

PRET MATERIEL D'EXPOSITION

Supports d'exposition

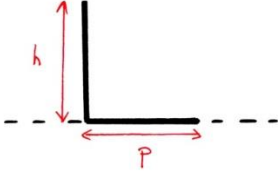

<u>Désignation</u>	<u>Visuel</u>	<u>Dimensions en mm</u> (sauf indications contraires)	<u>Profondeur utile en mm</u>	<u>Quantité</u>
Support droit plexi	 A diagram of an L-shaped support. The vertical leg has a height labeled 'h' with a red double-headed arrow. The horizontal leg has a width labeled 'P' with a red double-headed arrow. Dashed lines extend from the ends of the horizontal leg.	Avec anti-dérapants H x l : 160 X 130	90	5
		Sans anti-dérapants H x l : 200 x 120	120	18



**Support incliné
plexi**



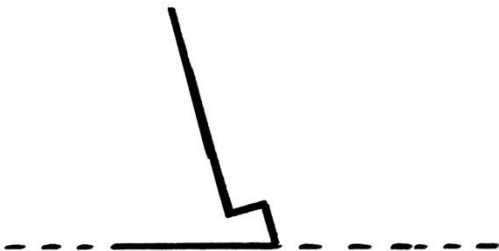

Sans rebord ni base droite : H x l : 280 x 210	160	1
Avec rebord : H x l : 160 x 38	110	2
Avec rebord : H 120 x L 38	115	5
Avec rebord : H155 x L38	155	4
Avec rebord : H155 x L80	150	6
Base droite : H x l : 80 x 40	125	2
Base droite : H80 x L100	200	10
Base droite : H80 x L60	125	8
Base droite : H120 x L60	180	8
Base droite : H x l : 130 x 100	175	2

Support livre simple plexi (avec rebord)		H : 180 x l : 300	160	1
		H : 205 x l : 155	105	2
Support incliné pour document à glisser		Format A4		4

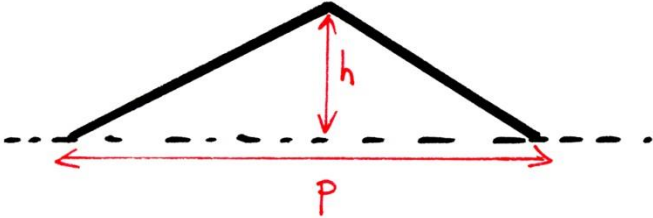
<p>Pupitre-vague plexi (sans rebord)</p>		<p>H X l : 220 X 200</p>	<p>240</p>	<p>3</p>	
		<p>H x l : 190 x 150</p>			<p>2</p>
<p>Support livre plexi</p>		<p>Format A4</p>			<p>2</p>

<p>Support livre à plat</p>		<p>H 125 x L 500</p>	<p>350</p>	<p>2</p>
<p>Support livre ouvert</p>		<p>H : 2550 DOS 40</p>	<p>1500</p>	<p>2</p>
		<p>H : 2550 DOS 80</p>	<p>1500</p>	<p>2</p>
		<p>H : 3250 DOS 80</p>	<p>2000</p>	<p>1</p>
		<p>H : 1550 DOS 40</p>	<p>1000</p>	<p>1</p>
		<p>H : 1550 DOS 30</p>	<p>1000</p>	<p>1</p>
<p>Lutrin plexi</p>		<p>H : 160 I : 400</p>	<p>320</p>	<p>1</p>
		<p>H : 210 I : 400</p>	<p>460</p>	<p>1</p>

Lutrin inclinaison réglable		L : 280	Petit modèle P : 210	3
		L : 375	Grand modèle P : 220	3
Chevalet droit réglable		max. H 600 x L 800 mm		2

<p>Chevalet de table -3 positions de réglage-</p>		<p>200 x 300</p>		<p>2</p>
		<p>300 x 400</p>		<p>2</p>
	<p>Chevalet muni de 3 encoches pour régler la position du dossier</p>	<p>400 x 500</p>		<p>2</p>

**Chevalet de table
-3 positions de réglage-**

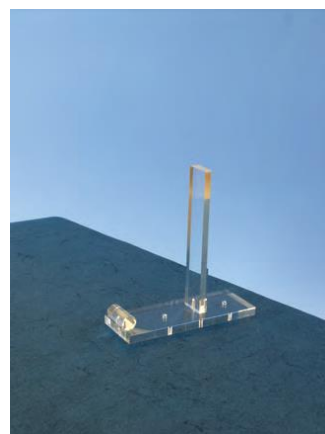

**3 positions pour
placer le dossier**

150 x 200

2

200 x 300



2

300 x 400

2

400 x 500

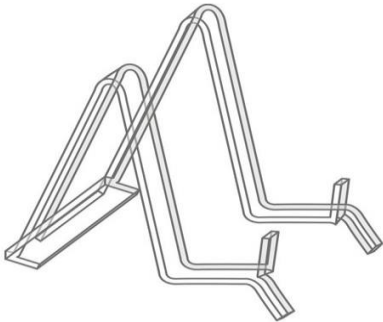
2

Chevalet -porte assiette (emboitable)		PM : ouverture 16 cm Dos H 15 cm		5
		GM : ouverture 20 cm Dos H 22 cm.		5
Chevalet-porte assiette		I X H : 70 X 80	80	2
		I X H : 105 X 125	110	2
		I X H : 14 X 155	125	6
		I X H : 220 X 230	155	2
Chevalet articulé plexi		H : 100		2

Support revolver plexi		H : 110		1
		H : 150		1
Cubes plexi numérotés		Arrête de 15		n. r.
Porte-médaille, décoration, monnaie		L X I : 75 X 160		2
		L X I : 100 X 120 (pour médaille de 7 à 8 cm)		4

**Support
médaille,
monnaie**



I X H : 15 X 30

3

I X H : 20 X 44



3



I X H : 25 X 55

3

I X H : 40 X 66

3

Support-cascade plexi		2 marches : 200 x 100 chacune Ensemble : H : 100 x L : 185	190	1
		2 marches : 100 x 100 chacune Ensemble Hauteur : 100	190	1
		3 marches : 200 x 60 chacune Ensemble : H : 140 x L : 140	160	1 (1 pied manquant)
		3 marches : 100 x 60 chacune Ensemble Hauteur : 140	160	1
		3 marches : 100 x 100 mm chacune Ensemble Hauteur : 140	280	1
		3 marches : 200 x 60 mm Chacune Ensemble Hauteur : 140	160	1
		3 marches : 200 x 100 mm Chacune Ensemble Hauteur : 140	280	1

<p>Support-cascade plexi</p>		<p>4 marches : 200 x 60 mm chacune Ensemble Hauteur : 190</p>	<p>200</p>	<p>1</p>
<p>Support pétales carrés plexi</p>		<p>4 niveaux (carrés de 120) H : 300</p>		<p>1</p>
		<p>4 niveaux (carrés de 120) H : 250</p>		<p>1</p>
		<p>3 niveaux (carrés de 100) H : 250</p>		<p>1</p>
<p>Support pétales ronds plexi</p>		<p>3 niveaux (ronds de 90 de diam.) H : 260</p>		<p>2</p>

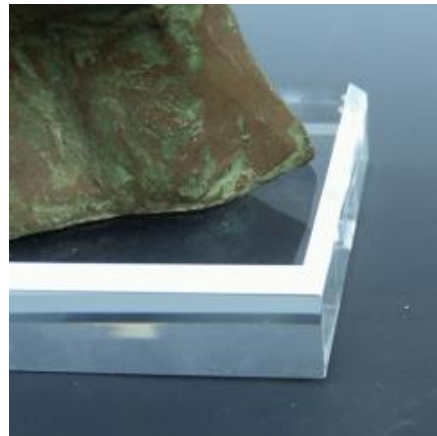

Platine biseautée





H20 x L60	60	5
H20 x L80	80	5
H15 x L30	30	5
H20 x L40	40	5
H20 x L100	100	5
H20 x L70	50	5
H20 x L100	70	5
H20 x L120	90	5
H25 x L120 EPAISSEUR 2.5	120	5
H25 x L150 EPAISSEUR 2.5	150	5
H25 x L150 EPAISSEUR 2.5	120	5
H25 x L200 EPAISSEUR 2.5	150	5

Platine (Disque)		Ø 80 x H 20		9
		Ø 100 x H 20		9
Support Massif	Rondin 	D : 80 H : 80		3
		D : 50 H : 100		3
		Ø 50 x H 50 à 60		7
		D : 50 H : 80		1
		D : 80 H : 50		2

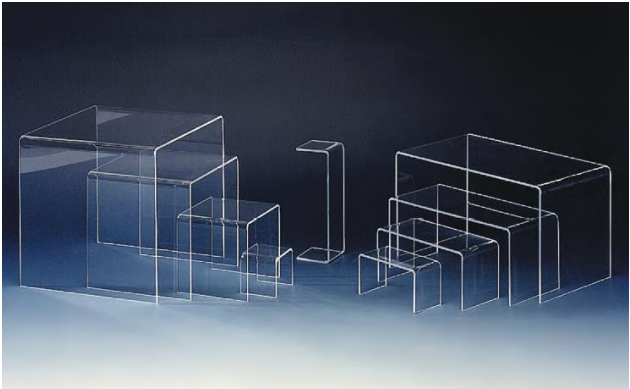
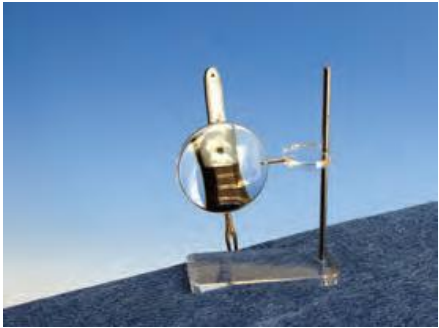

Support Massif	Rondin		Ø 50 x H 100	4
			Ø 60 x H 80	4
			Ø 100 x H 80	2
			Ø 100 x H 140	2
	Parallélépipède		50 x 50 H : 100	5
			60 x 60 H : 140	2



<p>Support Massif</p>	<p>Barreau</p> 	<p>200 x 50 H : 30</p>		<p>2</p>
<p>Gradin plexi</p>		<p>2 marches : H 400 x L 500</p>	<p>200</p>	<p>1</p>
		<p>2 marches : H 400 x L 500</p>	<p>400</p>	<p>1</p>
		<p>3 marches : H 360 x L 540</p>	<p>200</p>	<p>2</p>



Praticable plexi		H 200 x L 200	200	1
		H 150 x L 150	150	1
		H 100 x L 100	100	1
Loupe sur tige réglable		Grossissement x 2 : H max : 130 Socle : 90 x 40 Diamètre : 55		8 (dont 3 avec support- plaque blanche possible pour mise en valeur objet)

<p>Support magnétique</p>		<p>H tige 150 objet 250 gr max</p>		<p>2</p>
	 <p>Détail : support magnétique orientable avec double articulation</p>	<p>H tige 150 objet 1,5 kg max</p>		<p>1</p>

Support arme blanche plexi		H 180 X 300	50	2
		H 60 x L 100	50	2
		H 100 x L 120	50	2
Soclage modulable pour plateau de présentation plexi	<p>Pont Plateau EP 5mm</p> 	H x l : 50 X 45		2
		H x l : 25 X 80	80	1
		H x l : 50 X 80	80	1
		H x l : 75 X 80	80	1
		H x L : 60 X 180	120	5
		H x l : 75 X 45		2
		H x L: 120 x 180	120	7
		H x L: 180 X 180	120	7

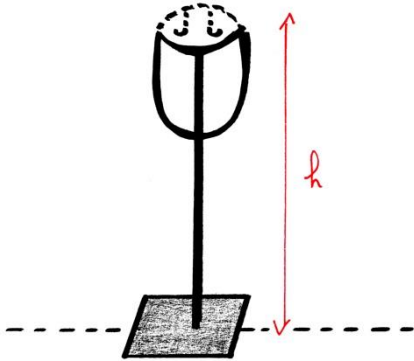
Soclage modulable pour plateau de présentation plexi	Module en V 	H x l : 90 x 60		2
		H x l : 120 x 60		2
		H x l : 155 x 60		2
	Socle pour module en V 	Dsique Ø : 90		6
		Rectangle L x l : 220 X 90 (2 écartements possibles)		1
		Rectangle L x l : 350 x 90 (2 écartements possibles)		1

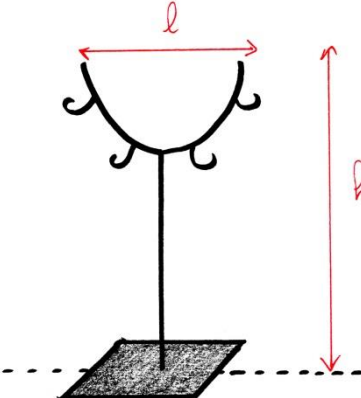
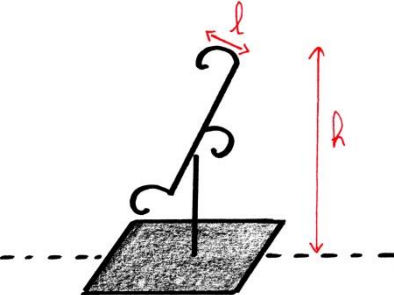
<p>Porte-cartel plexi</p>	<p>Etiquette droite</p> 	<p>L x l : 40 x 30 Epaisseur : 8</p>		<p>38</p>
<p>Support tunique</p>		<p>L : 300 H : 670</p>		<p>1</p>
<p>Support coiffure fer noir + mousse</p>	<p>deux modèles de tête</p>	<p>H : 320</p>		<p>1</p>
<p>Support masque fer noir (pouvant aussi recevoir coiffure)</p>		<p>H : 630</p>		<p>1</p>

Support fer noir		H x l : 330 x 300		1
		H x l : 190 x 30		1
Buste		Adulte		1
		Enfant		2

Mannequin mousse		Adulte		9
		Enfant		1
Buste bijouterie noir		H : 175		1
		H : 220		1
Plan noir incliné bois		L x l : 340 x 300 H : de 30 à 150		1

<p>Socle de présentation Tissu noir ou écru</p>		<p>Cube : 10 x 10 cm ép. 5 cm</p>	<p>Noir : 2 Ecrú : 2</p>
		<p>Cube: 20 x 20 cm ép. 15 cm</p>	<p>Noir : 2</p>
		<p>Cube: 20 x 20 cm ép. 15 cm</p>	<p>Ecrú : 2</p>
		<p>Parallélépipède : 10 x 20 cm ép. 5 cm Parallélépipède : 10 x 20 cm ép. 5 cm Parallélépipède : 20 x 30 cm ép. 15 cm</p>	<p>Noir : 2 Ecrú : 3 Noir : 3</p>

Coussin de présentation Tissu écru (avec housse)		GF Rectangle : L x l : 580 x 480		7
		MF Rectangle : L x l : 400 x 300		8 (dont 1 sans housse)
		PF Carré : Arrête de 200		4
Berceau Tissu écru	Démontable en deux parties chacun	L : 290		2
		L : 380		2